

USER MANUAL

DENVER F3™



IMPORTANT!!!

IT IS IMPERATIVE THAT YOU READ THE ENTIRE INSTALLATION AND OPERATING INSTRUCTIONS AND ADHERE TO THE SAFETY MEASURES DESCRIBED IN THIS DOCUMENT. DECOFLAME CANNOT BE HELD RESPONSIBLE FOR ANY DAMAGE CAUSED AS A RESULT OF NON-ADHERANCE TO THESE INSTRUCTIONS.

KEEP THE MANUAL IN A SAFE PLACE FOR FUTURE REFERENCE.

PLEASE STORE THE ORIGINAL PACKAGING IN CASE YOUR FIREPLACE SHOULD BE RETURNED TO THE FACTORY FOR REPAIR.

Use ONLY bioethanol with a pure alcohol percentage of 96.5 - 97.5% without additives or oils. Nor must the consistency be viscous or jelly-like - and nothing must be added to the bioethanol. Recommended bioethanol products are attached as a separate document.

CONTENT

1. PACKAGING	3
2. CONTENT OF THE BOX	4
3. GENERAL INFORMATION	4
4. POSITIONING AND SAFETY	4
5. <u>INSTALLATION</u>	5
5.1 WALL CONSTRUCTION	5
5.2 PREPERATION OF WALL	6
5.3. RECESS IN CAVITY WALL	7
5.4 INSTALLATION OPTIONS	7
5.5 PLACEMENT UNDER TV SCREEN	9
5.6 BURNER INSTALLATION PROCESS	10
6. <u>OPERATING INSTRUCTIONS</u>	11
6.1 OPERATING CONTROL PANEL	12
6.2 OPERATING REMOTE CONTROL	12
7. TROUBLE SHOOTING	13
8. MAINTENANCE	13
9. SAFETY ADVICE	14
10. EMPTYING THE FUEL TANK	14
11. BIOETHANOL	15
12. SYMBOLS	15
13. DISPOSAL AND RECYCLING	15

1. PACKAGING

Upon receiving the fireplace, take notice of the following:

The fireplace can be packed in:

- 1) A cardboard box with polystyrene inside and placed on a pallet.
- 2) A wooden crate with polystyrene inside and with 50-100mm wooden support for easier handling with a fork- or pallet lift.

Damages of the packaging

Please check the state of the cardboard box or the wooden crate while the courier is still there for visible damages.

If any damages are visible on the packaging it is **EXTREMELY IMPORTANT** to write a report remark about them on the delivery note, in the presence of the courier. Afterwards it is very important to contact Decoflame immediately with the following documentation:

- 1) Photos of all 4 sides of the pallet or wooden crate/cardboard box.
- 2) A description and explanation of the damage.
- 3) A copy or a photo of the delivery note from the driver/courier with the written remark and tracking number.

Contact the courier company immediately and inform them about the damage. Please remember to inform the tracking number.

Hereinafter Decoflame will contact you within the following 3-5 working days.

When you remove the fireplace from the pallet or take it out of the box, please follow the instructions below carefully.

Unpacking the fireplace

Lift or drive the whole box or crate as close as possible to the place where the fireplace is going to be mounted or installed.

Open the box or wooden crate carefully without causing scratches or damages.

We recommend use of drilling machine with TX20 or screw driver. Make sure that you slowly and carefully take out the fireplace and place it down on a flat surface without dropping it.

Please make sure that every item or part is wrapped out of the foam foil. If anything is missing please contact Decoflame immediately or send an email describing the missing parts together with photos of the contents in the box.

It is very **IMPORTANT** to keep the wooden crate or the cardboard, in case the fireplace will need to be returned to Decoflame for service

or repair. In the situation where the original packaging is not available anymore, Decoflame can send a new wooden crate. For further information about the costs, please contact Decoflame.

Damages of the Fireplace

If the packaging is not damaged and corresponding to the images sent by Decoflame with the tracking number, the wooden crate/cardboard box can be open.

If you notice any damage on the fireplace, the following information needs to be sent with Decoflame:

- 1) Photos of all 4 sides of the pallet / wooden crate AND the fireplace.
- 2) A description and explanation of the damage.
- 3) A copy or a photo of the delivery note from the courier with the written remark and tracking number.
- 4) Contact the courier and inform them about the damages. Please remember to inform the tracking number.
- 5) Contact Decoflame by email and enclose all documents according points 1-4. Please remember to inform the tracking number and order number (4-5 digits e.g. 6878 or 10149. The order number can be found on the delivery note from Decoflame or from your retailer).

The deadline for claiming transport damages is maximum 3 working days from the date of delivery. Thereafter, the delivery is considered and flawless and accepted. Complaints in this connection can therefore no longer be invoked.

Contact information at Decoflame:

Decoflame ApS
Vang Mark 2
9380 Vestbjerg
Denmark
Tel. +45 96 30 48 00

(Opening hours:
Mon-Thur. 08:00-16:00 and Fri. 08:00-15:30 Danish Time)
Email: logistics@decoflame.dk
Attention line in the email: Order number (4-5 digits).

Decoflame refers to The General Sales and Delivery Terms. If any questions or doubts please contact Decoflame or local retailer.

DO NOT

1	DO NOT open the box or wooden crate with sharp objects.
2	DO NOT flip the cardboard box or wooden crate on the sides or on the top. The arrow stickers MUST be followed carefully.
3	DO NOT use a hammer or other hard objects.
4	DO NOT use saws or other similar objects.
5	DO NOT smoke near the fireplace as there might be bioethanol
6	DO NOT lift in the parts which are sensitive to lifting and bending.

2. CONTENT OF THE BOX

1. Denver e-Ribbon Basic F3™ burner, with power cable attached
2. User manual
3. Remote controller
4. Glass screen and glass holders as purchased
5. Electronical Filling Pump

3. GENERAL INFORMATION

All Decoflake fireplaces are designed, manufactured and quality-tested in Denmark with the highest product safety and user-friendliness in mind. Denver e-Ribbon Basic™ with CEVB Technology (Controlled Ethanol Vapour Burning Technology) can be operated via control panel. Alternatively, the burner can be operated with a remote controller or with Bluetooth/Decoflake App.

Safety is imperative when dealing with open fire. Please strictly adhere at all times to all safety measures described in this manual.

4. POSITIONING AND SAFETY

Make sure that your fireplace is installed in a safe place indoors, which means in a wall made of non-flammable material with a distance of at least 1 meter to e.g. curtains - or furniture as shown below. (Figure 3.1)

Choose a position for your fireplace which is not exposed to any draught, as bioethanol is a volatile fluid. In fact, only the vapour of the bioethanol is burning when lit.

You should **NOT** touch the flames of the lit fireplace or blow into the flames.

Keep a distance of at least 300mm moving past the fireplace, as your movement may have an impact on the flames. The electronics of your Decoflake fireplace require a connection to a power socket (220-240V earth \perp – 50Hz – 1kW), which ideally should be placed inside the wall cut-out.

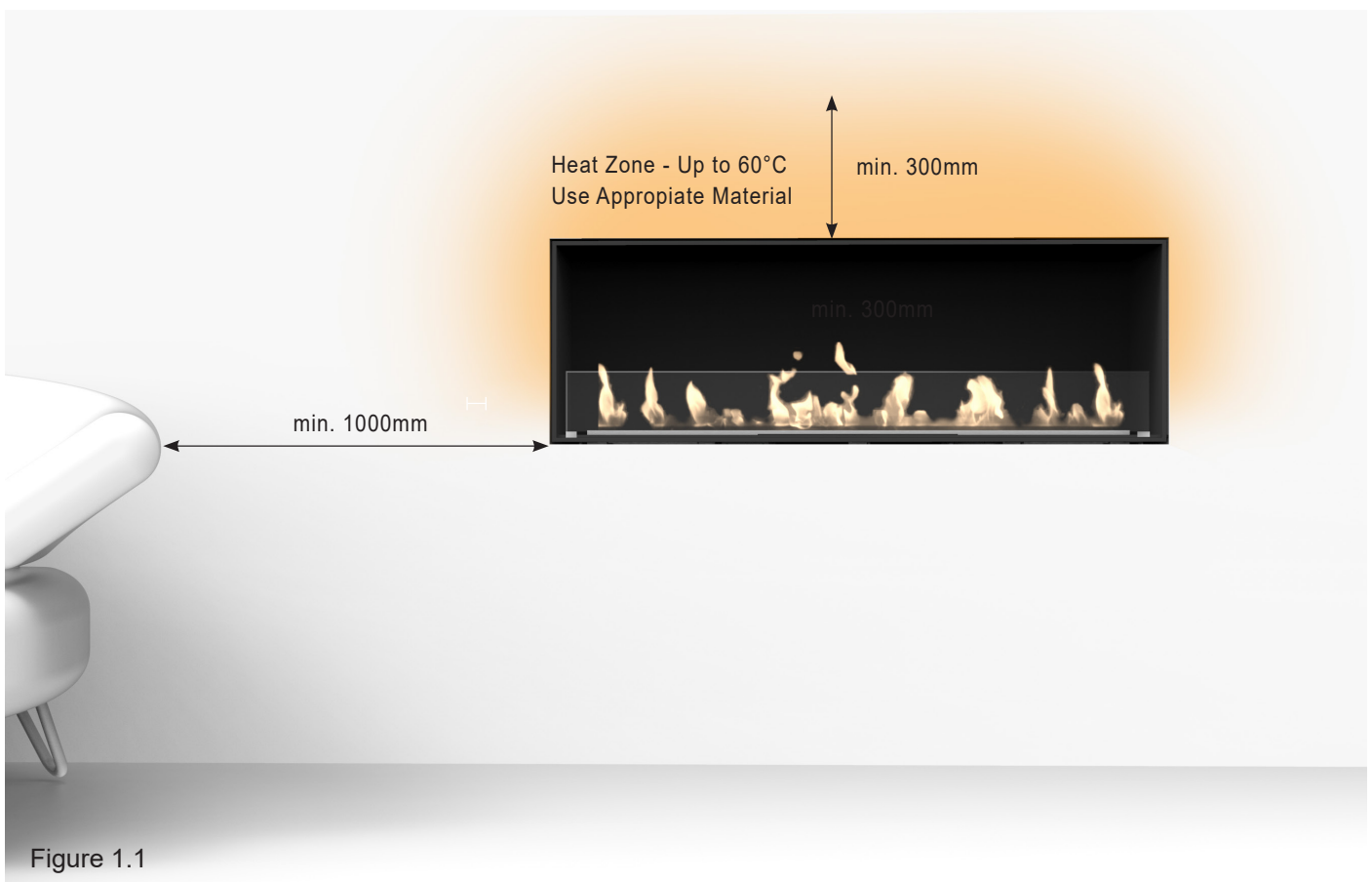

Figure 1.1

5. INSTALLATION

Please read and follow the detailed installation instructions on your technical drawing, which have been compiled for your DecoFlame bio fireplace. In here you will find all dimensions and a step-by-step installation guide. It is only advisable to install your DecoFlame bio fireplace, after all craft work in the room has been completed, to avoid damages to the bio fireplace, casing or glass.

Walls surrounding the built-in bioethanol burner must be constructed of or at least covered with non-flammable material such as plasterboard, Fermacell, GypRock FireLine or brick.

The supports on the left and right sides inside the cut-out (on which the fireplace are placed) must be made of robust, NON-flammable material such as metal, concrete or brick. The supports must be in level.

If you are in the slightest doubt about how to install the fireplace, as well as what screws to use for your wall type, consult a professional and authorized craftsman, who is able to perform the installation correctly.

Note that the electronically controlled Denver e-Ribbon Basic™ needs one ground connection to operate.

There should therefore be an electrical outlet at the bottom of the cavity - ideally to the right - where the fireplace is to be mounted.

When installing Denver Basic F3, use:

- Electric drill / screwdriver
- Drill bits (Suitable for the type of material you want to attach the top and bottom plate to the bio fireplace).
- Spirit level and measuring tape
- Screws (suitable for the type of wall)
- Wall plugs or expansion bolts (suitable for the type of wall)

5.1 WALL CONSTRUCTION

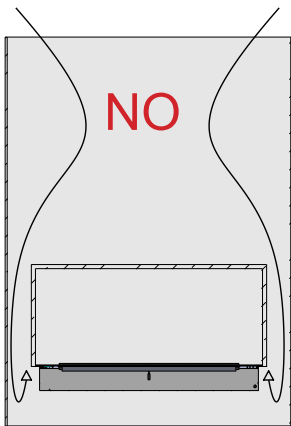

DO NOT! install the Denver e-Ribbon Basic in a wall construction, which is open above and below fireplace. The warm air will cause turbulences inside this hollow construction, which will have a negative impact on the flames.

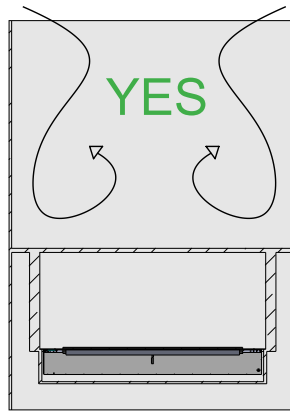

DO! install the Denver e-Ribbon Basic in an open-wall construction, which is closed above and below the fireplace. Make sure to create a closed cavity for the section below and baseplate of the fire.

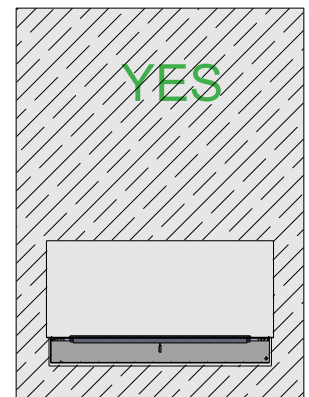

DO! install the Denver e-Ribbon Basic in a massive wall (made of bricks, stone or gas beton) using the wall cut-out dimensions mentioned on the previous page.

5.2. PREPERATION OF WALL

The fireplace hole must be constructed in a non-flammable material with regard to DS / EN 13501-2. The biofireplace wall must have a BS construction.

Here, the material must meet the minimum A2-s1, d0, e.g. concrete or plaster.

The fireplace hole must be **hermetically sealed** in both top and sides, so that false drafts cannot occur.

This also applies to the cable outlet, where it is either grouted around the cable or closed with non-flammable foam.

Decoflame recommends that you do NOT joint around the casing of the fireplace. The 5mm shade edge ensures that the fireplace can both ventilate and insulate, so that heat migration in the wall is minimized. In addition, there is a risk that the joint will crack and / or discolor during time.

NOT APPROVED (1-4)

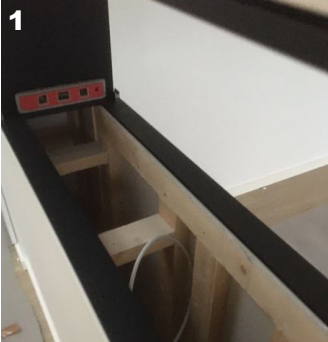

1 The hole for the burner is lined with wood.



2 Too much space around the wiring, must be grouted.



3 The fireplace wall is not secured against false draft in the sides.



4 The wall is not hermetically sealed at the bottom, which can cause drafts.

APPROVED (5-8)



5 The fireplace wall closed at the top and sides.



6 Power plug 3-pin (Ground).



7 All cross-measures must be at an angle.

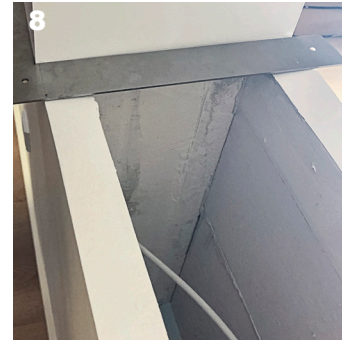

8 The 2 wall must be in level.

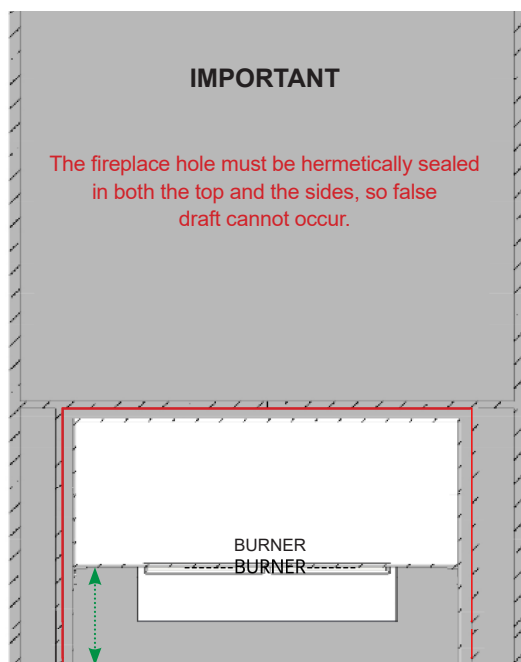

5.3 RECESS IN CAVITY WALL

PLASTERWALLS - WOOD SKELETON WALLS

The wall cut-out must be carried out in accordance with the supplied drawings.

Walls surrounding the built-in bioethanol burner must be constructed of, or at least covered by, non-flammable material such as fiber gypsum boards (eg Fermacell, GypRock FireLine) or brick.

Important: The cavity above the fireplace MUST be hermetically sealed and also under the bio fireplace. (Make a cavity wall division just above the top of the fireplace)! Internal socket and cable glands must be grouted so that everything is hermetically sealed due to false draft. If there is a cavity wall above the bio fireplace, this must also be hermetically sealed.

STONE / BRICK WALL

The cut-out must be made according to the handedout drawings. Brick wall is considered to be of non-flammable material.

IN GENERAL

Make sure the notches in the wall and the support of the left and right sides under the base plate of your Denver e-Ribbon Basic™ burner, is level and all corners of cutouts are at a 90 degree angle.

Use a spatula, metal or straightening rail to achieve straight edges on the hole.

For specific dimensions, please refer to the detailed technical drawing from Decoflame. If in doubt, please contact your Decoflame Retailer or Decoflame.

If the bio fireplace is installed in a room with a wooden ceiling or similar material, it must be ensured that the distance between the top of the fireplace and the ceiling is at least 1 meter. When choosing the height placement of the bio fireplace, one must take into account small children and pets.

During operation, the surfaces of the biofireplace on the upper part of the fireplace as well as any glass will be hot, as the heat rises up- and outwards. If there are children or pets in the house, an adult should always keep an eye on them while operating the biofireplace and never leave the biofireplace unattended when it is lit.

5.4. INSTALLATION OPTIONS

Burner size:

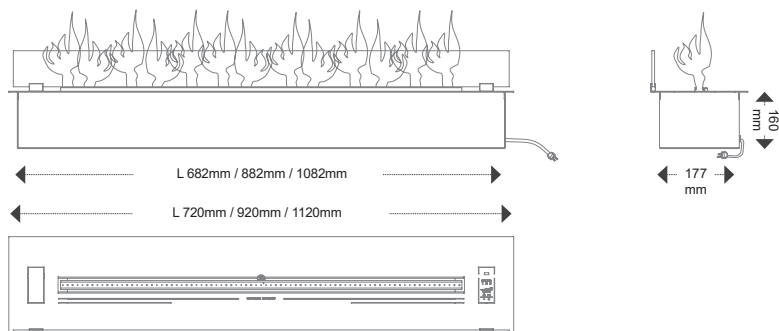

The Denver Basic F3 is available in 3 standard sizes.

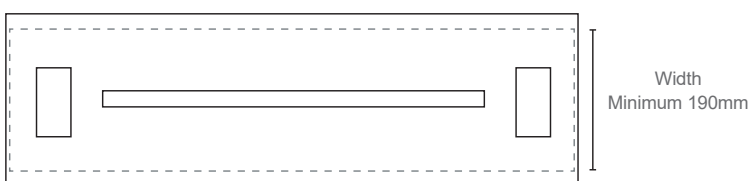

The hole in the cavity wall must be at least 300mm deep and 190mm wide.

The length of the hole depends on the burner model, 720, 920 or 1120. For all models, +20mm is added to the length for the box insert.

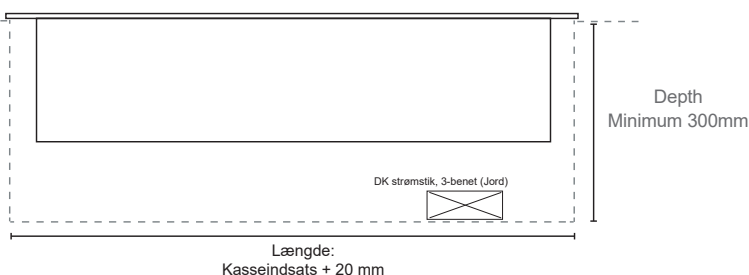

The hole for the box insert must be made in a non-flammable material.

Fixed dimensions:
Depth: Min. 300mm/Width: Min. 190mm.

Variable dimensions: Length: Box insert + 20mm.

Remember: Power outlet for Denver Basic must be placed down the hole.

INSTALLATION OPTIONS CONTINUED

1. Submerged in hole:

Min. 190mm Max.210mm

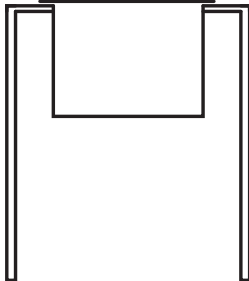

Denver Basic can be immersed in a hole in a half wall or similar. It is important that the hole is a minimum of 190mm in width and a maximum of 210mm.

2. Built-in wall / Casing:

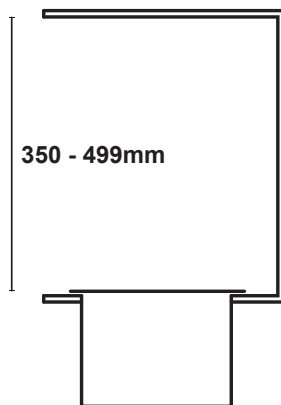

If the fireplace is built into the wall, there must be mounted a steel plate in the top or a casing in the hole – only if the height of the wall hole is 350 - 499mm.

Between the steel plate and the wall, there must always be 5mm gap in order both to ventilate, to insulate and minimize heat migration in the wall.

The Montreal and Orlando models are particularly suitable for this. The minimum height is always 400mm with the casing solution.

3. Brick wall without casing:

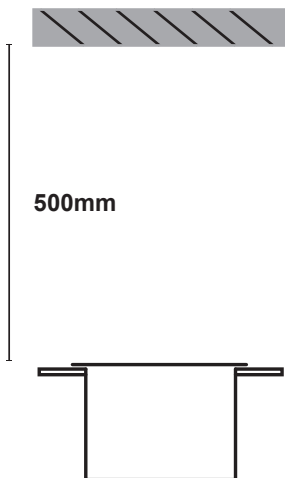

If you prefer having a brick wall and not a steel plate at the top of the wall hole, the height of the hole must be at least 500mm.

Failure to comply with this can, e.g. damage the joints between the bricks, as the heat migration becomes too high.

5.5. PLACEMENT UNDER TV SCREEN

NB: We **DO NOT** recommend placing TV screens or valuable paintings above the fireplace as the upwards drifting warm air might damage those.

Should you still want to create a setting incorporating a TV screens above the fireplace, please follow the instructions below or ask Decoflame for further advice.

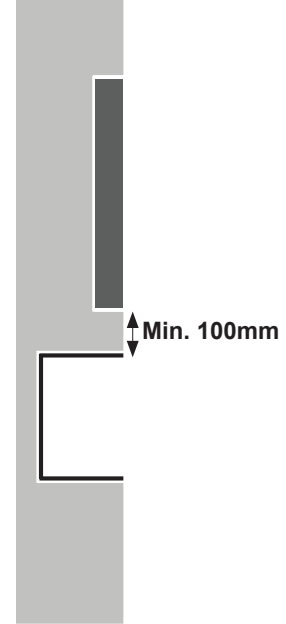
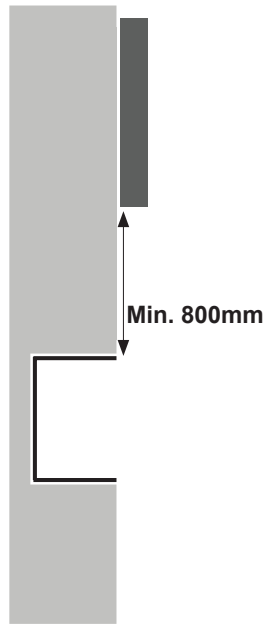
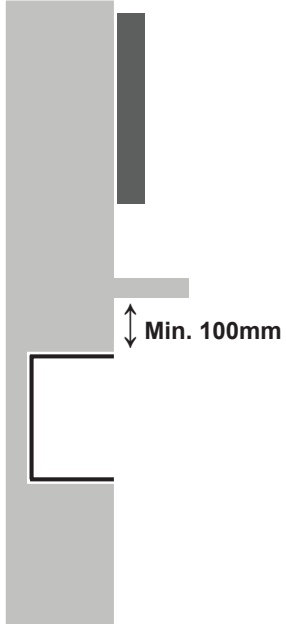

5.6. BURNER INSTALLATION PROCESS

There are different options for installing the fireplace model:

- > 1: Resting on top of the surrounding surface
- > 2: Immersed in recess.

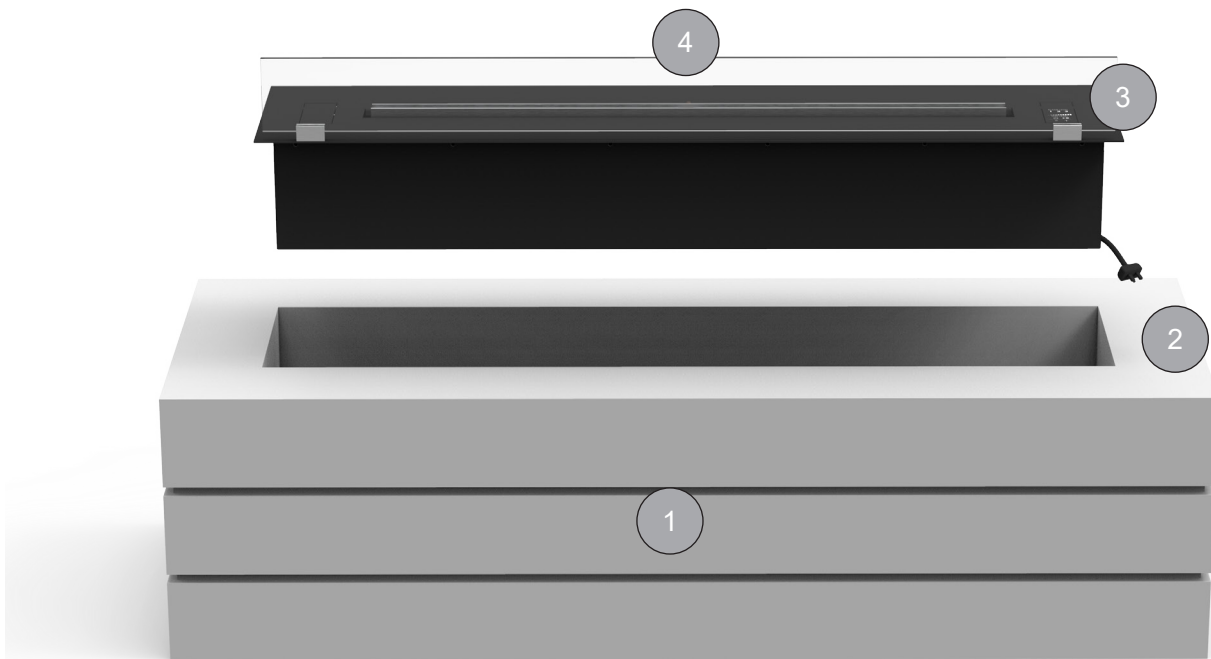

> STEP 1:

Check that the dimensions of the cutout are as shown on the accompanying technical drawing. All corners of the cutout must be at a 90° angle and all surfaces must be level.

Ensure that there is an active earth socket \perp inside the wall, placed at the bottom right - ideally below the level of the tank (lower than 160mm).

Also check that the cutout is prepared according to the desired method of installation (eg either with the base plate resting on the surrounding surface, with the edges of the cutouts prepared with a router, or using the included mounting brackets).

> STEP 2:

Carefully lift burner out of the packaging and place it on a flat surface. The fireplace must not be tilted.

Move the burner closer to the immersion hole and insert the plug into the outlet. Turn on the power outlet.

Carefully lower the biofireplace into the immersion hole.

> STEP 3:

When the biofireplace is positioned as desired, turn on the power connection using the button  that unlocks the fuel cover.

> STEP 4:

Carefully fit the glass screen(s) by inserting the glass holders into the holes in the top plate. Avoid scratching the top plate.

6. OPERATING INSTRUCTIONS

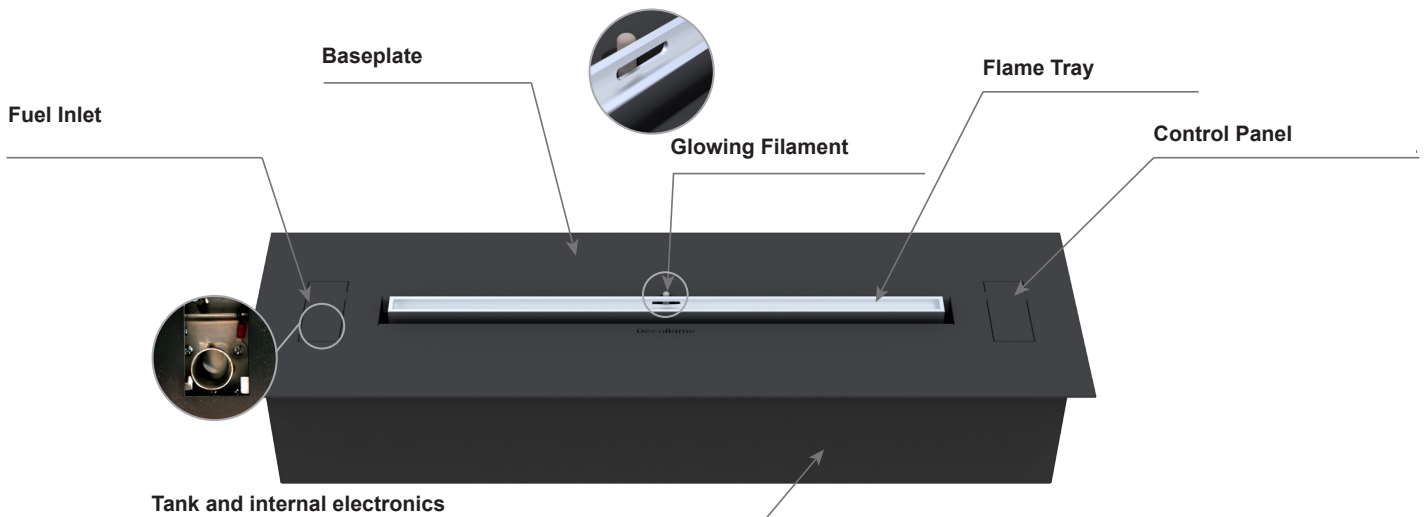

NOTE: The glowing filament must not be touched when it is lit as it is hot.
During cleaning - do not touch it as it is extremely fragile

ONLY ADULTS MAY OPERATE THE ELECTRONICS OF THE DECOFLAME DENVER F3™.

> TURN ON

Turn on the power connection to your Denver F6™ by pressing the  button.



> FILLING (Alcohol percentage 96.5% to max. 97.5%).



Open the cover of the fuel supply, insert the quick coupling and then the power plug from the pump.

During refueling, the lines indicating the fuel level will gradually rise, indicating that the filling process must stop.

The pump stops automatically when the tank is full.

Disconnects after filling is complete.

You can now start the fire by pressing the start button  on the control panel.

The glow lighter starts to glow and heat the bioethanol. After approx. 3-5 minutes flames appear.
Do not touch the glow plug when the bio fireplace is on, as it gets hot.

After 10 minutes of flames, the fireplace is operationally warm.
Until then, the flame height of the bio fireplace must NOT be regulated.
Be careful not to touch the glow plug as it is fragile and hot.

ATTENTION!:

1. You must not fill the tank as long as the fireplace is running.
2. The ignition process does not start if it is detected that the pump is still connected.
If you try to connect the pump while the fireplace is running, it will shut down.
3. You can first start the filling process when the fireplace is less than 90% full.
4. To open the fuel cap, the fireplace must be connected to an electrical outlet.
5. Bioethanol must NOT be poured onto a hot biofireplace - or into the flames.
6. Do NOT smoke while filling bioethanol, or near it.

> REFILLING

The fuel level lights - on the left - flash slowly when the tank runs out of bioethanol.

Preferably avoid turning off the power to the biofireplace.



FILLING CANNOT BEGIN UNTIL THE FIREPLACE HAS COOLED DOWN

When the indicators on the fuel level indicator have stopped flashing, you can start the filling process.
Connect the quick coupling from the pump first.

> START

Press the button ►■ on the control panel. After approx. 3. minutes you can see the first flames around the center of the burner tube. After this, it will take approx. 3. minutes until the fireplace heats up and the full width of the burner tube is filled with flames.

When the burner pipe shows flames across its entire width, the flames burn at the pre-set level.

You can change the flame level by pressing the -+ buttons on the control panel.

Once you have changed the flame level, wait 10 min. from the first flame before adjusting it further down or up to give the system the necessary time to react to the flame changes.

The control panel will go into standby mode (the lights on the control panel will turn off) if the flame level has not been changed for three minutes. To reactivate the control panel, simply press the ►■ OR -/+ button.

> SWITCH OFF

To turn off the fire - which also applies during the heating phase - press the button ►■ on the control panel.
The flames will then be extinguished within a few minutes.

You can now leave the power supply on standby without pressing any further buttons. You can also restart the flames as described above immediately.

> SWITCH OFF THE BIO FIREPLACE

To turn off the bio fireplace's power supply, press the button ⏻ on the control panel.

> UNWANTED INTERRUPTION OR POWER FAILURE

If you happen to press the button ⏻ and turn off the power supply by accident - or if you experience a power cut while the flames are still lit - the fireplace will turn off and the flames will disappear in a few minutes.

You can start the flames again as described above (when the power supply is back to normal). The heating phase is shortened if the burner is still hot from its previous ignition.

> SECURITY SYSTEM

The burner has a built-in safety system which means that the pump does not receive power until the fireplace is cold enough.

> bioethanol (FUEL)

Biofireplaces from Decoflame are designed and manufactured exclusively for use with bioethanol with a high alcohol percentage (96.5% to max. 97.5%).

DO NOT USE other fuel, other materials, lower quality bioethanol, or bioethanol containing oils and fragrances, as this will void your warranty. Bioethanol can be bought in specialist shops or on the internet - feel free to ask Decoflame for advice and recommendations.



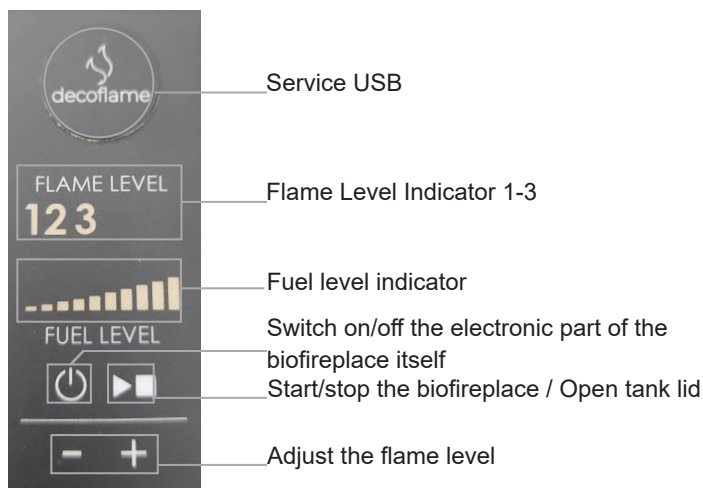

6.1 OPERATING CONTROL PANEL



6.2 OPERATING REMOTE CONTROL



7. TROUBLESHOOTING

ERROR ON DISPLAY	ERROR NAME	SYSTEM REACTION	EXPLANATION	ACTION TO BE TAKEN
	SPILL BOTTOM	The fire does not start, or the fire turns to auto-switch-off mode	Liquid has been detected inside the safety-chamber situated in the bottom of the housing of Denver e-Ribbon Basic™.	Dry off any spilled bioethanol thoroughly with (paper) towels. Leave the pop-up lid open for at least one hour in order to allow any remaining bioethanol to evaporate completely. Then close the pop-up lid of the fuel inlet.
	NO FLAME	The fire turns to auto-switch-off mode	The filament is not working or there is too much draft in the room.	Try to reduce the draft around the fireplace by closing any windows or doors. If that does not help, call your point of sale or go to decoflame.com and please fill in the service-form. Have the serial number ready.
	HOT TEMP. SENSOR	The fire does not start, or the fire turns to auto-switch-off mode	The built-in temperature sensor has detected too high a temperature inside the housing of the model.	Make sure that the fireplace has been installed according to the technical drawing and the installation manual and has sufficient natural ventilation. If the error keeps occurring, go to decoflame.com and please fill in the service-form.
	HOT EVAPO-RATOR	The fire does not start, or the fire turns to auto-switch-off mode	The built-in temperature sensor has detected too high a temperature inside the housing of the model.	Make sure that the fireplace has been installed according to the technical drawing and the installation manual and has sufficient natural ventilation. If the error keeps occurring, go to decoflame.com and please fill in the service-form.
	EMPTY FUEL TANK	The fire shuts down and cannot be started until refuelled.	The fuel level in the tank is too low or the tank is empty.	Do not switch off the electronics and fill the fuel tank as described in section 6.

For further information, refer to the SUPPORT page at www.decoflame.com

8. MAINTAINEMENT

Before starting to clean the fireplace, make sure it has cooled down and it is switched off completely.

The glass components of your DecoFlame fireplace are made of tempered heat-resistant glass. Those glass parts as well as any metal parts which are exposed to the heat of the fire might slightly change color or structure. This is to be considered normal wear and tear and does not constitute a product flaw or fault.

We recommend that, if needed, you clean all parts of your fireplace with a lint-free cloth or kitchen paper towel and a non-abrasive detergent, like bioethanol or another alcohol-based product.

Regarding polished steel surfaces use only a soft and clean cloth as the surfaces will easily be scratched by e.g. paper towels.

Should you wish to clean the flame tray, please avoid contact with the filament, as this delicate component can be easily damaged!

9. SAFETY ADVISE

Please always adhere to the safety advice given in this manual. Bioethanol fires are **REAL FIRES** and therefore, please use highest care and common sense when operating them.

DO

- DO** avoid contact of bioethanol with eyes and skin.
- DO** keep bioethanol safely and out of reach of children.
- DO** keep the quality of your room air at an adequate level by opening a window for around 5 - 10 minutes or by leaving the doors to adjacent rooms open. Should the premises in which the fire is situated be equipped with an MVHR System (Mechanical Ventilation with Heat Recovery), the room air quality will automatically be kept at a high level and no further action should be necessary.
- DO** avoid contact with any glass and metal parts of your fireplace as these can become hot during operation.
- DO** always adhere to all safety instructions given in this manual.

DO NOT

- DO NOT** smoke when filling the burner with bioethanol as it is – of course – extremely flammable.
- DO NOT** use lighters or matches to turn on the fireplace.
- DO NOT** use any other fuel than bioethanol of 96.5% but max. 97.5% alcohol purity.
- DO NOT** mix bioethanol with other fuels.
- DO NOT** cover/obstruct any of the ventilation slots of the fireplace.
- DO NOT** place any flammable materials or clothes near the fireplace.
- DO NOT** place any pebbles or stones on the burner as these will crack and might cause injury or damage to the fireplace.
- DO NOT** place any ceramic logs or ceramic pebbles on the burner as they will obstruct the ventilation slots in the baseplate and change the combustion temperature.
- DO NOT** install the fireplace outside.
- DO NOT** attempt to open the housing of the fireplace.
- DO NOT** modify anything on your custom-made Decoflame bioethanol fireplace.
- DO NOT** touch the filament during cleaning.

IN EMERGENCY:

Follow these guidelines in case of fire:

We recommend that you have a fire extinguisher located near the bio fireplace in case of fire.

Suitable extinguishing media: carbon dioxide CO₂, dry chemical, powder, foam, chemical foam, alcohol-resistant foam, water spray.

In the event of minor fires:

Use chemical substances, carbon dioxide (CO₂), water mites or alcohol-resistant foam.

In the event of major fires:

Use alcohol-resistant foam or water spray for larger fires.

UNSUITABLE EXTINGUISHING METHOD:

DO NOT use water jet! Do not rinse the floor with water.

Vapors may move over the surface of the external ignition source and cause the ignition to restart.

If it is assessed that the fire is out of control, contact the fire authorities immediately.

10. EMPTYING THE FUEL TANK

It is very important that the fuel tank is empty if the biofireplace has to be moved or if it has to be sent to Decoflame ApS for additional technical assistance.

To empty the tank, reverse the coupling on the pump and follow the filling instructions.

11. BIOETHANOL

BIOETHANOL IS EXTREMELY FLAMMABLE!

Use ONLY bioethanol with a pure alcohol percentage of 96.5 - 97.5% without additives or oils. Nor must the consistency be viscous or jelly-like - and nothing must be added to the bioethanol. Recommended bioethanol products are attached as a separate document.

STORAGE CONDITIONS

Always follow the instructions on the bioethanol packaging. The bioethanol must be stored safely and out of the reach of children! The bioethanol must only be stored in original and correctly marked cans. The container must be tightly closed.

Store in a relatively cool, dry and ventilated room away from sources of ignition, oxidizing agents and incompatible materials. Take preventive measures precautions against the generation of static charge. The bioethanol must be at room temperature before it can be ignited.

SAFETY MEASURES

Preventive measures: Avoid inhalation of vapours. Avoid contact with eyes, skin and clothing. People prone to skinallergy or lung disease, should not come into contact with bioethanol. Use the general precautions related to work with chemicals.

FIRE PREVENTION MEASURES

Due to the high flammability of the product, the special fire protection measures at the storage location must be followed very carefully. Protect the container from overheating. Bioethanol must be stored in a fireproof container and out of the reach of children.

Avoid bioethanol coming into contact with heat, sparks and fire. Keep away from incompatible materials such as metal or alkali products. Flash point 13 degrees Celsius / boiling point 78 degrees Celsius. The fireplace can be difficult to start if it is below room temperature.

If you suspect consumption of bioethanol, contact the poison line on tel.: +45 82 12 12 12 for further advice.

DO NOT

1	DO NOT use any other fuel, materials or bioethanol of inferior quality as this will void your guaranty.
2	DO NOT use any sentences or oils to your bioethanol as this will void your guaranty.
3	DO NOT mix bioethanol with other fuels as this will void your guaranty.

*Denatured Bioethanol is classified as:
Flammable Liquid Class 1B (for Flammability)
Class 3 PGII (for Transportation)
UN1170 (Identification Code)
Regulated by various standards around the world.
You must familiarise yourself and comply with these regulations in order to safely and legally store, handle, decant and use this fuel.*



12. SYMBOLS



Do not pour directly onto the flames



Do not fill on a hot burner



Do not place the biofireplace near flammable material



Protect the biofireplace from drafts



NO smoking



Do not blow into the flames



Do not touch the flames



Have proper extinguishing equipment ready



Follow the instructions regarding fuel and fire blanket



Warning - combustible material



Health hazard

13. DISPOSAL AND RECYCLING

The made to measure Decoflame bioethanol fireplace is made of aluminium, stainless steel, glass(es), copper, plastic and electronic components. If you wish to dispose of the appliance, please adhere to the regional rules and regulations.

You will find, that most parts of your Decoflame fireplace can be recycled.

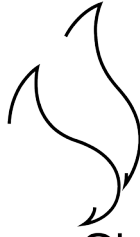

decoflame

Decoflame ApS
Vang Mark 2
9380 Vestbjerg, Denmark

tlf. +45 9630 4800
info@decoflame.dk
www.decoflame.com

RATING PLATE

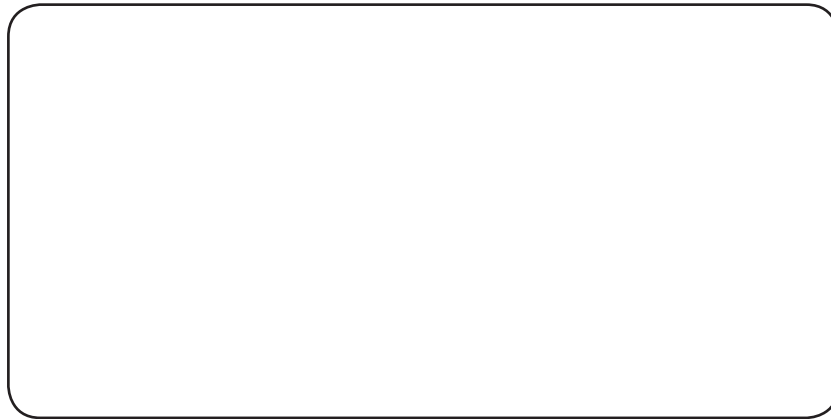

Service links:

<https://decoflame.com/support/>
<https://decoflame.com/service-form/>

Follow the Fire Authorities and national and local requirements regarding bioethanol fireplaces.

*Subject to typographical errors and technical errors.
Decoflame ApS reserves the right to make changes without notice.
We refer to Decoflame's General Terms of Sale and Delivery.*

V0123